

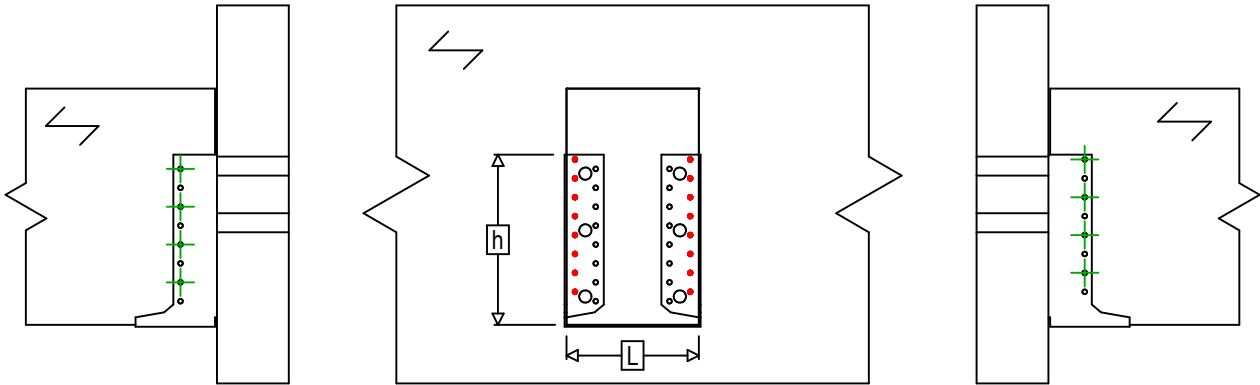

Referencia =	SAIL500		
Fijaciones =	Madera sobre madera	Viga sobre viga	
Sistema de fijación =	Clavado parcial		

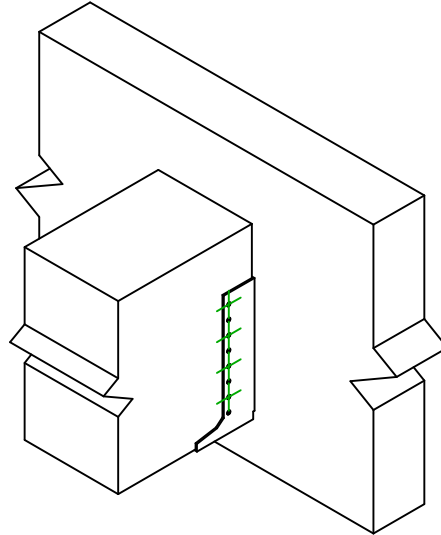

$$h = (500 - L) / 2$$



Fijaciones Soporte	Símbolo	Fijaciones	Fijaciones		Ctd	
		CNA		CNA4.0X35 / CNA4.0X50		
		CSA		CSA5.0X35 / CSA5.0X40		
-		-	-			
Fijaciones Viga Secundaria	Símbolo	Fijaciones	L < 64mm	L > 64mm	Ctd	
		CNA		CNA4.0X35		CNA4.0X50
		CSA		CSA5.0X35		CSA5.0X40